

Thank you for choosing Better Bathrooms.
Please read this manual before installing your product
and keep for future reference.

LED MIRROR WITH WIRELESS CHARGING SHELF

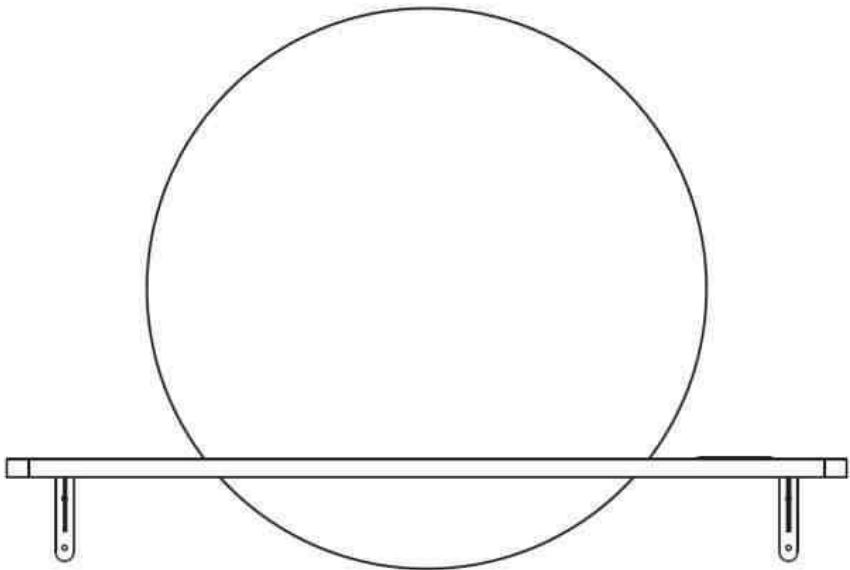

BeBa_27008

BeBa_27009

ERSA0500

- CONTACTLESS CONTROL
- LED ILLUMINATION
- WIRELESS PHONE CHARGER
- DEMISTER
- IP44 INGRESS PROTECTION

CONGRATULATIONS ON YOUR PURCHASE

Our aim at Better Bathrooms is to bring you extraordinary bathroom products, for less.

If you're after a modern, traditional, or a totally unique style bathroom, we have the fittings and fixtures to bring your ideas to life, so you can fall in love with your space every day.

We hope your new product goes above and beyond your expectations. However, should any problems occur, please:

- Log in to your account and contact our customer services team via your self-service portal – betterbathrooms.com/CustomerAccount/Login
- Contact us via betterbathrooms.com/contact/contact-us

CONTENTS

SAFETY	3
BATHROOM ZONES	4
PARTS SUPPLIED	5
TOOLS REQUIRED	5
INSTALLING THE MIRROR	6
PRODUCT OVERVIEW	9
OPERATION	9
CLEANING AND MAINTENANCE	10
TECHNICAL SPECIFICATIONS	11

SAFETY

- This mirror should be installed by a qualified electrician.
- This fitting is only suitable for connection to a 220-240V earthed supply in accordance with current IEE wiring regulations, and should be installed in accordance with local Building Regulations.
- This is for domestic, indoor use only.
- The fitting should be connected to a dedicated lighting circuit which must be protected by a 5-amp fuse (or a 6-amp miniature circuit breaker).
- Before installing the fitting ensure the mains supply is switched off, and that the appropriate fuse is removed (or appropriate circuit breaker is switched off) before commencing installation. Ensure that measures are taken to prevent the supply from being inadvertently reconnected.
- If there is a “Minimum Distance” Label, please do not allow Flammable Materials to come within that distance from the unit.
- This product may contain delicate parts – be careful during handling and maintenance to avoid breakage.
- If any modification is made to the fitting it will invalidate the warranty and may render the product unsafe.
- A defective appliance may cause electric shock. Never switch on a defective or damaged appliance. Disconnect the appliance from the mains before seeking assistance.
- This product is IP44 rated, and no part of the installation is allowed to be within bathroom Zones 0 or 1. Installation is permitted within Zone 2.
- This product must be earthed. Before commencing installation, ensure that there are no pipes or wires located behind the wall that may be damaged during drilling.
- Ensure that the hanging location has been decided upon and marked clearly to avoid unwanted damage in the wall due to incorrect positioning.
- Check that the mirror is not damaged prior to installation.
- Take care unpacking, do not use a sharp blade to open as this may damage the mirror and void your warranty.
- Installation must only be carried out by a qualified professional or electrician.

BATHROOM ZONES

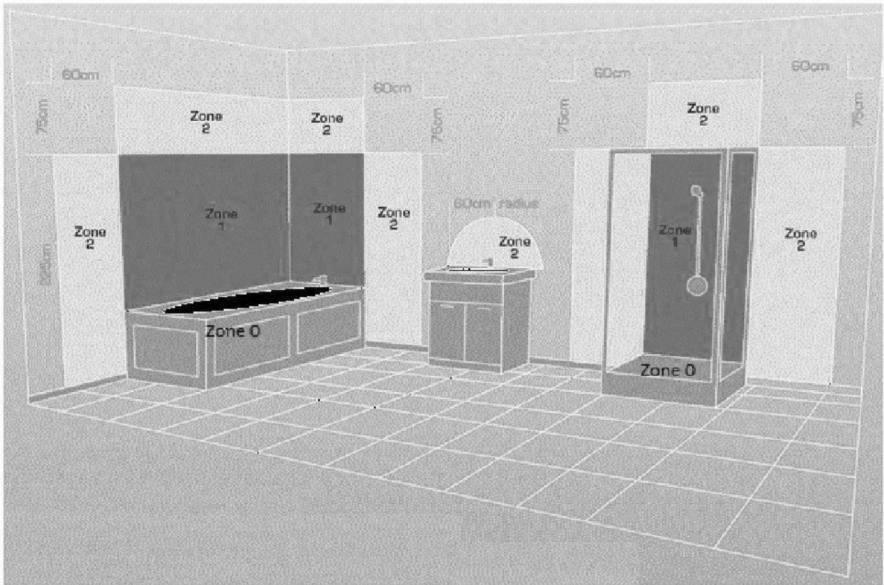

Zone 0:	The interior of the bathtub or shower basin.
Zone 1:	The area around the bathtub or shower basin up to a height of 2.25m above the floor
Zone 2:	The area stretching to 0.6m outside the bath or shower and above the bath or shower if over 2.25m

PARTS SUPPLIED

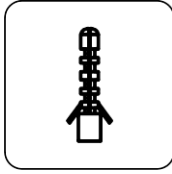

WALL PLUGS (X8)

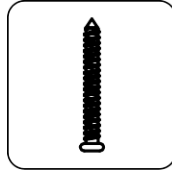

SCREWS M4 (X8)

PLEASE NOTE: It is the installers responsibility to ensure that the fittings are suitable for the type of wall. Alternative fittings may be required (Not Supplied). If unsure professional advice should be sought.

TOOLS REQUIRED

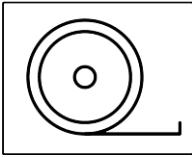

TAPE MEASURE

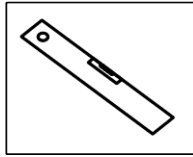

SPIRIT LEVEL

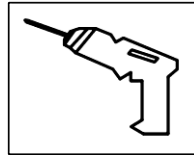

ELECTRIC DRILL

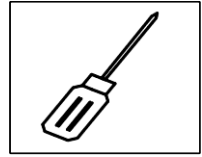

SCREWDRIVER

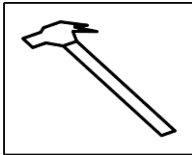

HAMMER

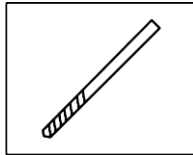

8mm DRILL BIT

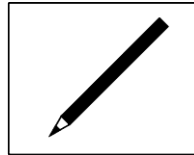

PENCIL

INSTALLATION

First of all, the mirror should be hung on the wall over the wiring. Then, once the mirror is installed, the shelf is added.

Before drilling, ensure that no wires or pipes are behind the wall. If unsure, seek professional advice.

1. Looking at the back of the mirror, measure the distance A between the fixing centres of the mounting holes.

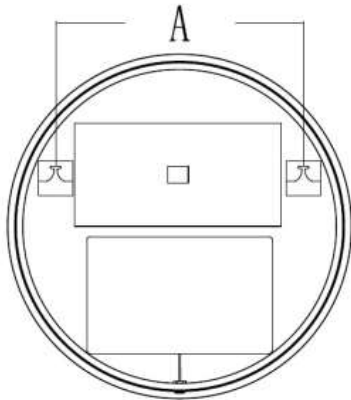

2. Ensuring that a 20cm space is left below the bottom edge of the mirror (for the correct operation of the intra-red sensor), Use a spirit level and a pencil mark two points on the wall separated by this distance.

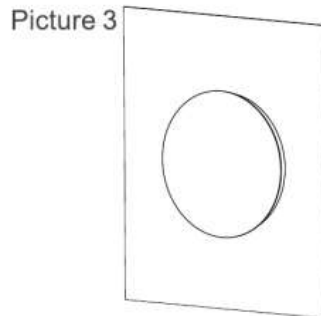
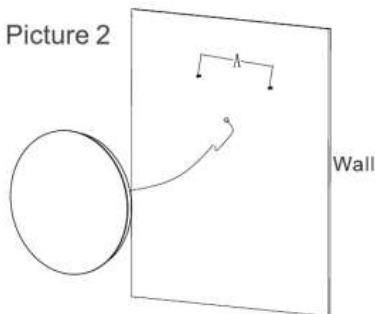

3. Use a drill to make two holes.
4. Insert the wall plugs and screws.
5. Switch off power.

6. Connect the wiring to the lamp as below:

Picture 4

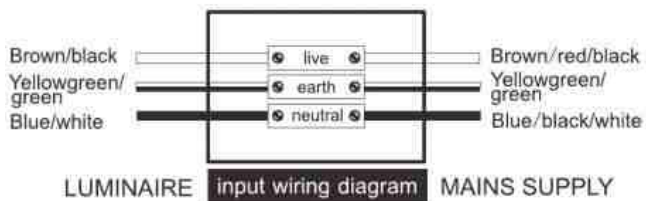

7. Hang the mirror on the screws.
8. Reconnect the power and test the product.
9. Switch the power back OFF.

Picture 5

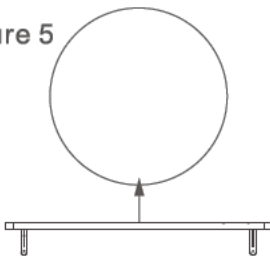

Picture 6

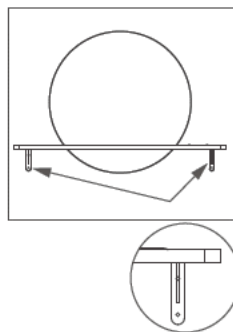

Enlarged view

10. Position the shelf in a suitable position and use a pencil to mark the corresponding screw hole positions.
11. Drill holes in the marked positions.
12. Insert the wall plugs.
13. Place the shelf over the wall plugs and fix it to the wall with the screws

Picture 7

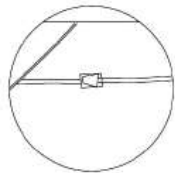

Enlarged view

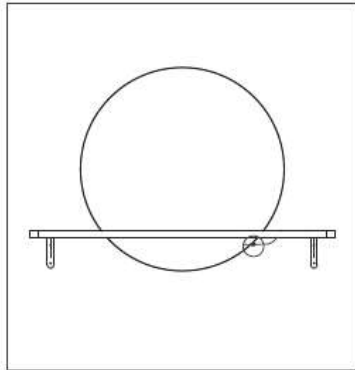

14. Connect the charger to the wire on the back of the mirror.

15. Turn the power back on and test the function of the charger

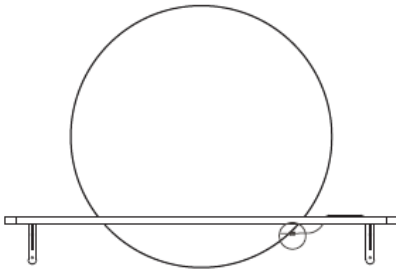

PRODUCT OVERVIEW

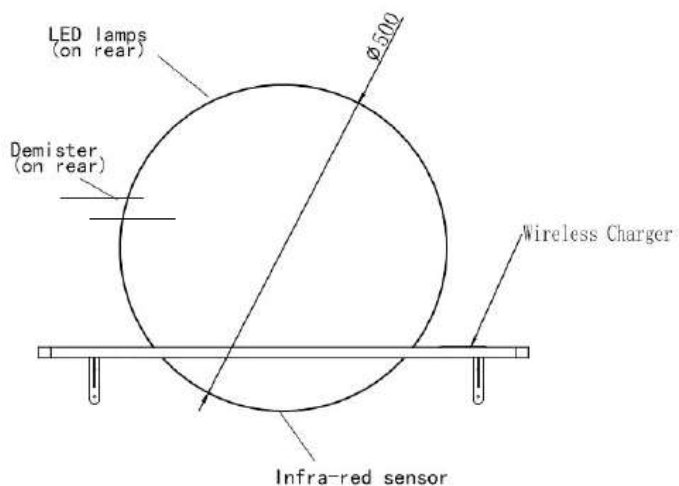

OPERATION

When the mirror is connected and hung securely onto the wall, turn the mains power back on and the mirror will be ready to use.

Your mirror has an infrared sensor located on the bottom. To activate the light, charger and the demister, move your hand across the sensor once at a distance of around 5cm.

To turn the light, charger and demister off, move your hand across the sensor again.

Hold your hand in front of the sensor to change the colour temperature of the light. The charger works independently, when the product connect to the main supply, it begins to work.



CLEANING AND MAINTENANCE

Never use products containing bleach or abrasive cleaners, as these will have a detrimental effect on the appearance and lifespan of the product.

Use a clean micro fiber cloth to clean the mirror.

TECHNICAL SPECIFICATION

Model	BeBa_27008 (white) BeBa_27009 (black) ERSA0500(Oak Shelf)
LxHxW (mm)	500x500x150
Net Weight (Kg)	4.5
Power Cord length (cm)	35
Rated Power	32W (Max)
IP Rating	IP 44
Input	220 V - 240 V 50 Hz

This product contains a light source of energy efficiency class<F>.

DISPOSAL

Recycling facilities are now available for all customers at which you can deposit your old electrical products. Customers will be able to take any old electrical equipment to participating sites run by their local councils.

Please remember that this equipment will be further handled during the recycling process, so please be considerate when depositing your equipment. Please contact the local council for details of your local household waste recycling centres.



At the time of printing the product contains no substances listed within Annex XIV of the Reach Regulations (EC) 1907/2006. In accordance with Article 59 of the same regulation the following substances are contained within the product at permitted levels: Cadmium.

As a responsible manufacturer the regulations are monitored to ensure continued compliance. Further information can be provided upon request.

V20230728

For more information

- visit betterbathrooms.com
- email customerservices@buyitdirect.co.uk
- call 0330 390 3062
- write to Trident Business Park, Neptune Way, Huddersfield, HD2 1UA

**better
bathrooms**

Part of the BuyItDirect Group